

THIS DRAWING IS UNPUBLISHED. RELEASED FOR PUBLICATION 20
COPYRIGHT 20 Y ALL RIGHTS RESERVED.

LOC H DIST -

REVISIONS				
P	LTR	DESCRIPTION	DATE	APVD
	F2	ADDED NOTE INDICATING POLARISATION SLOT	29OCT2012	SP RP

REFERENCE MATING INTERFACE PATTERN:
1,27 STAGGERED PITCH x 1,5 ROW-DISTANCE.

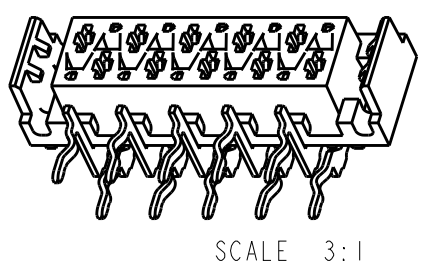
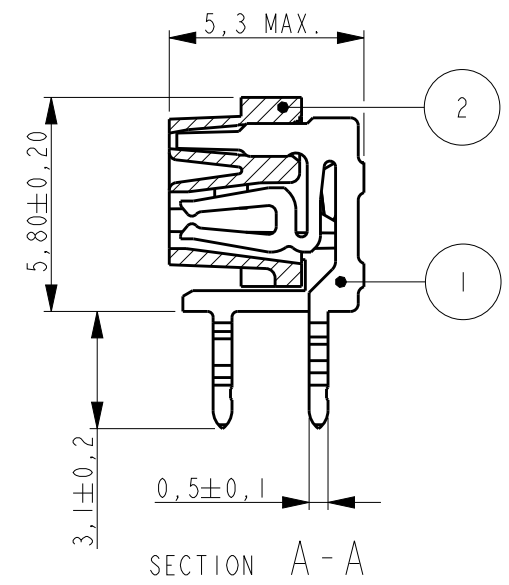
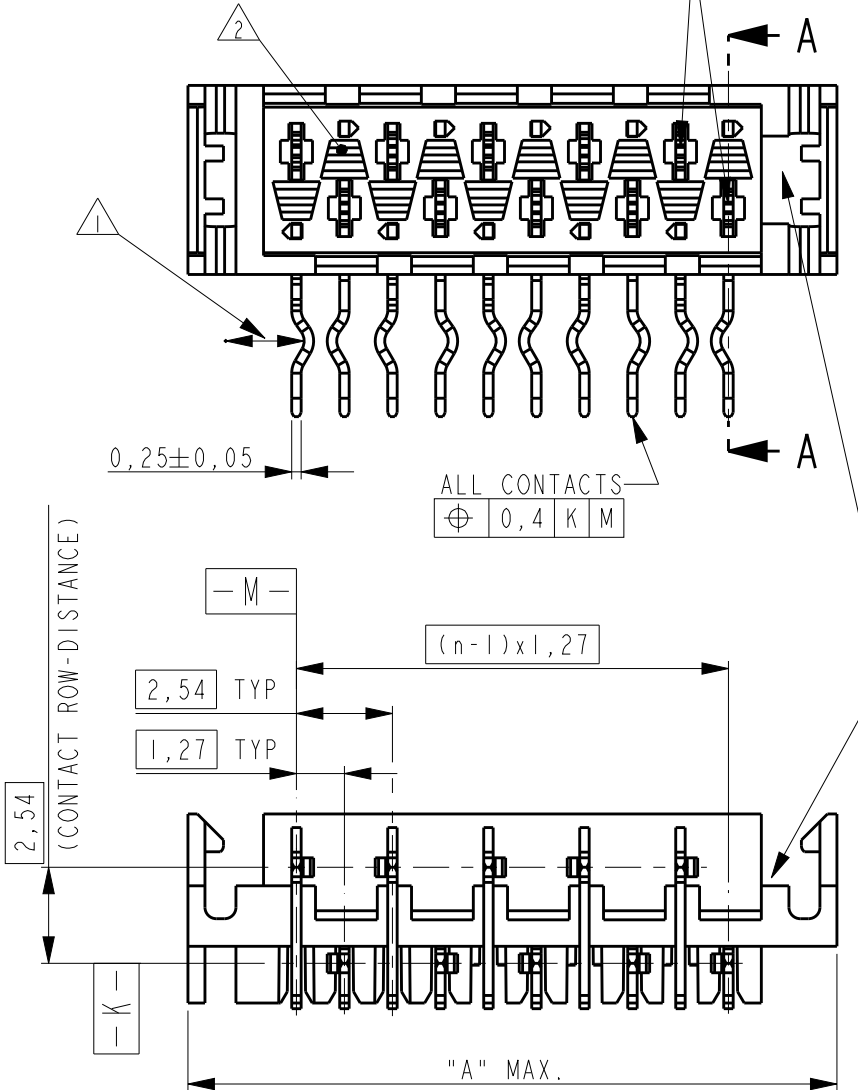

PART NUMBER	NR. OF POS "n"	"A" MAX
338070-4	4	9,7
338070-6	6	12,2
338070-8	8	14,7
1-338070-0	10	17,3
1-338070-2	12	19,8
1-338070-4	14	22,4
1-338070-6	16	24,9
1-338070-8	18	27,4
2-338070-0	20	30,0

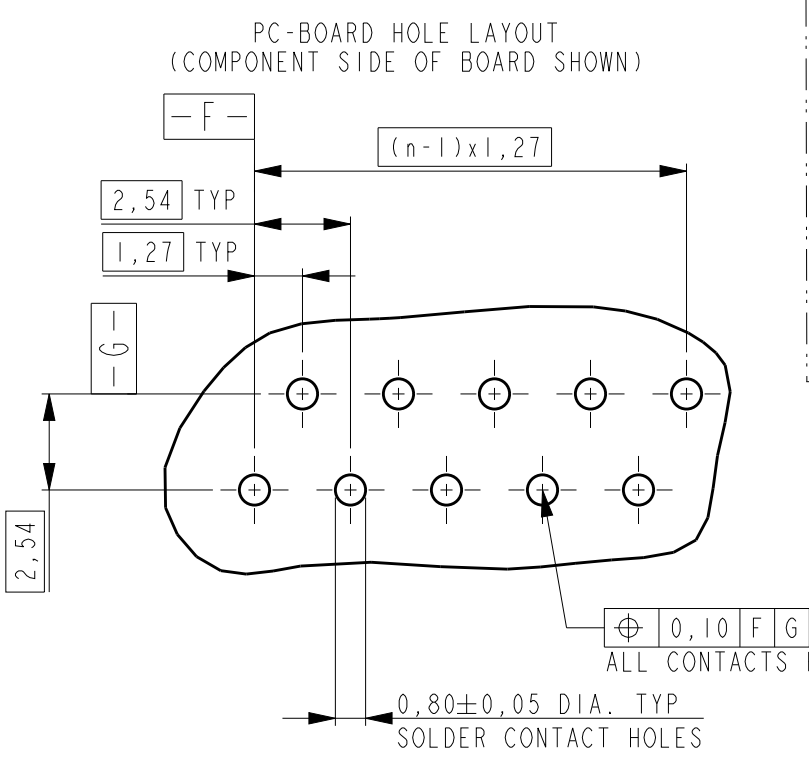

POLARISATION SLOT

NOTES:

- 1 IN EACH ROW, DIRECTION OF KINKS STARTS RANDOM.
IN EACH ROW, SEQUENTIAL CONTACTS HAVE OPPOSITE KINK DIRECTIONS.
- 2 CORING-OUTS FOR MANUFACTURING PURPOSE ONLY.
SHAPE MAY VARY, BUT IS NOT FUNCTIONAL FOR THE APPLICATION.
- 3 SHOWN IS A 10 POSITION CONNECTOR.
- 4 THIS AREA IS RESERVED FOR CONTACTS.

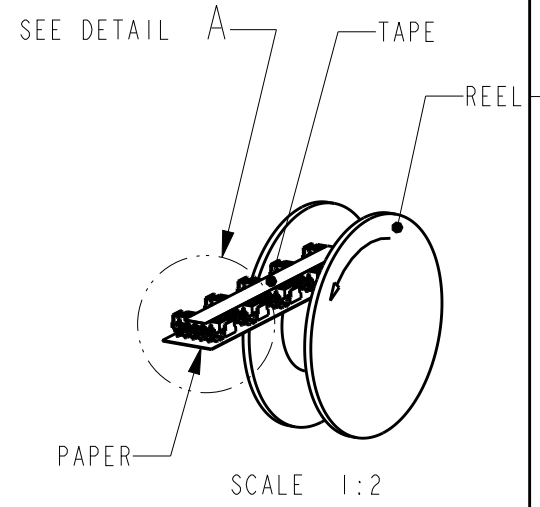
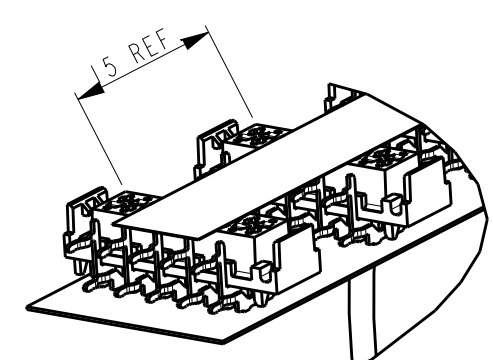
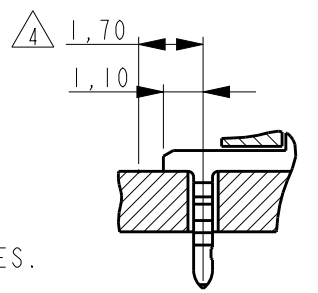

REEL PACKAGING
DEREELING DIRECTION AND CONNECTOR POSITION.
QUANTITY 2500 CONNECTORS PER REEL FOR ALL PART NUMBER,
EXCEPT 4 POSITION 1500 CONNECTORS PER REEL.

THIS DRAWING IS A CONTROLLED DOCUMENT.

DIMENSIONS:	TOLERANCES UNLESS OTHERWISE SPECIFIED:
mm	
0 PLC	±-
1 PLC	±-
2 PLC	±-
3 PLC	±-
4 PLC	±-
ANGLES	±1°
MATERIAL	FINISH

2	HOUSING	G.F. POLYESTER PBT	RED
1	FEMALE CONTACT	PHOSPHOR BRONZE	TIN OVER NICKEL
ITEM NO.	DESCRIPTION	MATERIAL	FINISH / COLOR
DWN 03-JUN-96	DENNIS KESSLER		
CHK	HUUB VAN DELFT		
APVD	ERIC IJLJENS		
PRODUCT SPEC	108-19052		
APPLICATION SPEC			
WEIGHT			
CUSTOMER DRAWING		SCALE 10:1	SHEET 1 OF 1
		REV F2	



CONNECTOR, FEMALE-ON-BOARD,
SIDE-ENTRY, THRU-HOLE,
WITH LATCHES, Micro-MatCh

SIZE	CAGE CODE	DRAWING NO	RESTRICTED TO
A3	00779	C-338070	-