

THIS DOCUMENT IS SUBJECT TO CHANGE WITHOUT NOTICE. IT IS CONFIDENTIAL AND A PROPERTY OF Amphenol LTW. DISCLOSURE TO THIRD PARTY HAS TO BE AUTHORIZED BY Amphenol LTW.

REV.	ECN NO.	DATE	SIGN	DESCRIPTION
B	LEN14C0032	2014/11/21	Vicky	Update Logo, Dime. & Pin Assignments

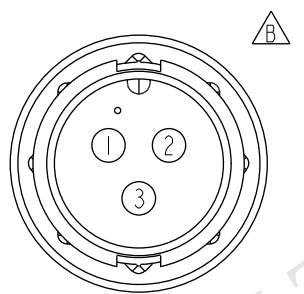

Pin Assignments
Front View

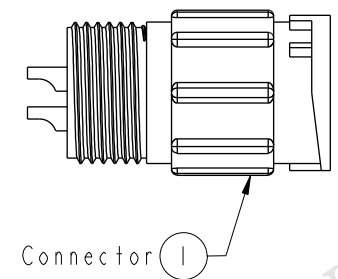
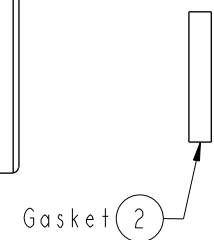
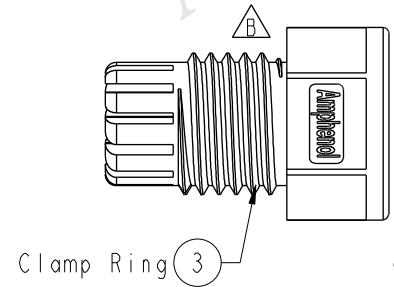
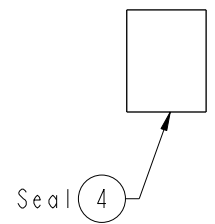
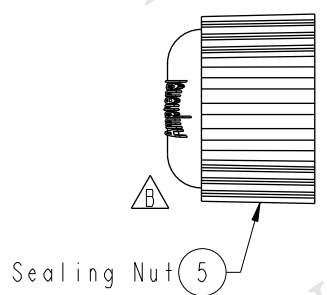
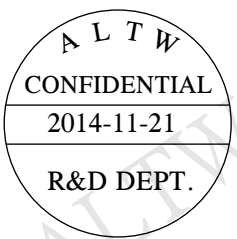
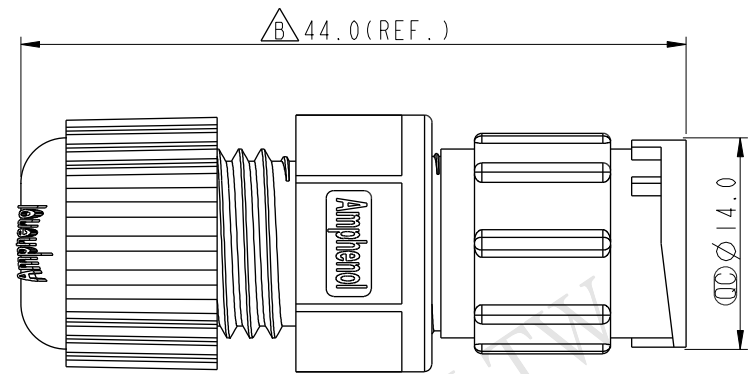

Note:

- * CC Important Dimension To Check.
- * Waterproof Rate: IP67
- * Housing: Nylon+GF, Black
- * Male Pin: Copper Alloy, Gold Plated
- * Gasket: EPDM, Black
- * Clamp Ring: Nylon, Black
- * Seal: EPDM, Black
- * Sealing Nut: Nylon, Black
- * Seal For Cable OD: $\varnothing 4.5\text{mm} \sim \varnothing 6.5\text{mm}$
(防水墊圈線徑: $\varnothing 4.5\text{mm} \sim \varnothing 6.5\text{mm}$)
- * One Set Unassembled In One PE Bag
(每一組未組裝, 放置於一個PE袋, 並封口)

UNIT: mm TOLERANCE .X ±0.25 .XX ±0.1 .XXX ±0.05 ANGLES ±1°	TITLE Standard Assy Lock 3P M Conn M Pin			Amphenol LTW 安費諾亮泰企業股份有限公司		ITEM NO BD-03BMMA-LL7001	DRAWN BY Vicky	DATE 2014-11-21
	SCALE 3:2	SIZE A4	SHEET 1 OF 1			DWG NO BD-03BMMA-LL7001	CHECKED BY Sam	DATE 2014-11-21
	REV. B	WC-REV. A.2	CC : Inspection item	CUSTOMER ALTW	APPROVED BY Rita	DATE 2014-11-21		
								8 FMM10702-01-02A1